

PRODUCT DETAILS

The BiANCO NXT MULTI-SP is the perfect solution whether you need to boost water pressure. Compact, quiet and efficient, the MULTI-SP is a 'self-priming' booster pump, able to draw water up into the pump from shallow wells or submerged tanks. Supplied prewired with the award-winning BiANCO NXT PRO controller, the user can choose between pump operating modes making MULTI-SP the perfect solution for domestic household supply, water transfer or light irrigation / horticultural use in rural and semi-rural applications.



APPLICATIONS

- Household water supply
- Pressure boosting
- Light commercial applications
- Water transfer
- Washing systems
- Light Irrigation

FEATURES

- Pre-wired, dual mode, auto-restart pump controller
- Digital display
- Dry-run, frequent start, maximum run time protection
- Built from high quality materials
- Self priming operation

TECHNICAL DATA

OUTPUT POWER (KW)	0.55kW P2
MAX. HEAD [M]	42M
MAX. FLOW L/MIN	98 l/min
MAX PRESSURE	Pump: 8 bar Controller 10 bar
LIQUID TEMPERATURE	2 - 40 deg C
MOTOR	Asynchronous TEFC
MOTOR INSULATION	F Class insulation
MOTOR PROTECTION	In-built thermal overload
PROTECTION CLASS	IP45
PRESSURE TANK	0.3 litre controller volume 3, 8 or 18 litre recommended

RATED VOLTAGE	220 - 240V 1Ph 50 Hz
RATED CURRENT	3.6A
CAPACITOR	16uF 450V
POWER CABLE	1.2m long 10 amp rated H05 flex 10 amp 3 pin plug
AUTOMATIC OPERATION	Yes - Dual mode NXT PRO
PUMP BODY	Stainless steel
INTERNALS	Composite impeller / diffusers
MECHANICAL SEAL	Silicon Carbide/Carbon
PACKAGE DIMENSION	460 x 230 x 420
GROSS WEIGHT (KG)	12kg

Fitment of an additional pressure tank is mandatory when the controller is set to MODE 2 (Digital Pressure Switch)

CURVE

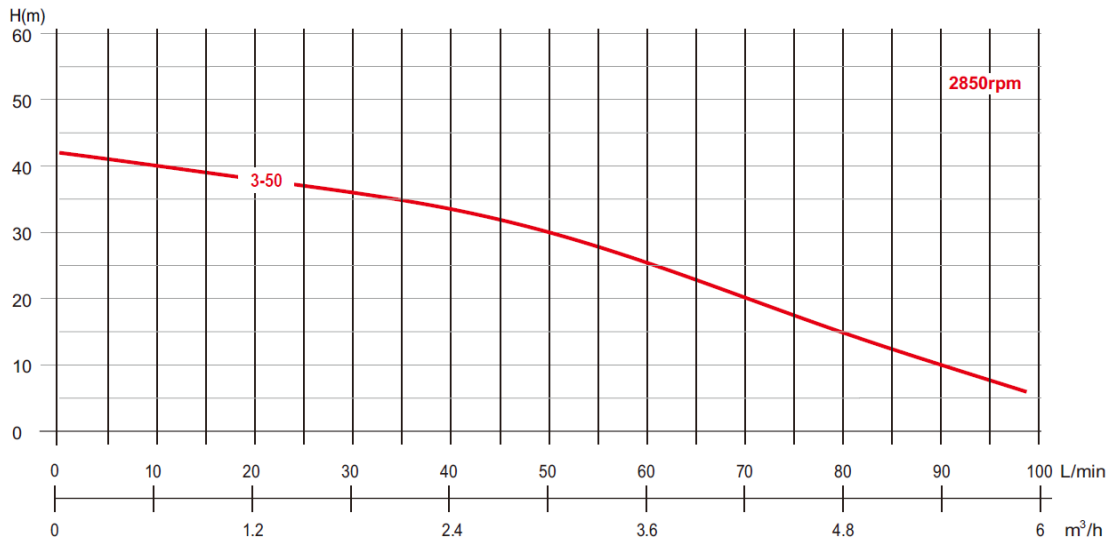

DIMENSIONS

HEIGHT WITH CONTROLLER FITTED

402mm

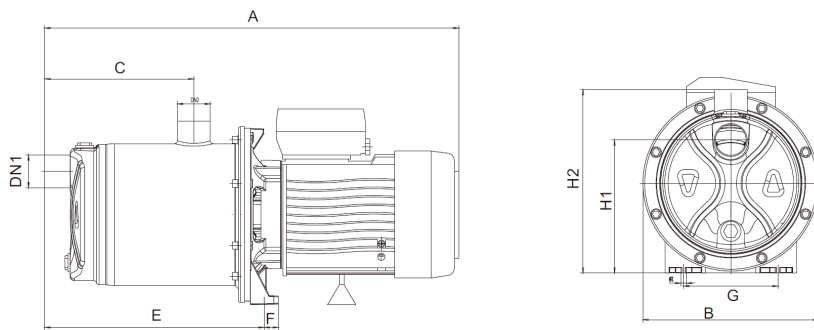

A	B	C	E	F	G	I	H1	H2	Dn1	Dn2
379	195.5	111	189	16	110	9	148	204	G1"	G1"

WARRANTY / CERTIFICATIONS

